



D R A P P E G G I
D R A P E R Y T R A C K S Y S T E M S



PLUS

1

LA GAMMA

Una gamma completa di sistemi professionali per tende arriciate ad uso domestico e professionale che offre la soluzione più adatta per qualsiasi drappoggio.

THE RANGE

A full range of curtain track systems suitable for domestic and professional use which offers the best solutions for all curtain styles and qualities of fabrics.

LA QUALITÀ

È la priorità del prodotto Mottura. Silenziosità e scorrevolezza come risultato di una tecnologia sofisticata per garantire una prestazione ed una longevità superiori.

THE QUALITY

At Mottura our main priority is Quality, with our sophisticated technology we can produce quiet and smooth running Curtain Systems and guarantee excellent performance and longevity.



2

SINERGIA

Un prodotto Mottura è il risultato dell'incontro tra la tecnologia Mottura e l'esperienza di migliaia di specialisti che da oltre quarant'anni la utilizzano ovunque nel mondo e contribuiscono ad una costante evoluzione del prodotto.

SINERGY

A Mottura system is a result of the advanced technology at Mottura and the experience of thousands of experts who over 40 years have contributed to the constant evolution of our products.

I MATERIALI

Mottura pone una estrema attenzione all'utilizzo di materiali più adatti alle performance del prodotto. Oltre trenta materiali diversi sono stati selezionati ed utilizzati nei sistemi Mottura per offrire la performance migliore e una longevità estrema.

THE RAW MATERIAL

Mottura sets very high standards and spends a great deal of time to ensure we use the best materials to produce a high level of performance from our products. Over thirty different materials have been selected and are used constantly in the systems produced by Mottura, to offer the best performance and a long life.

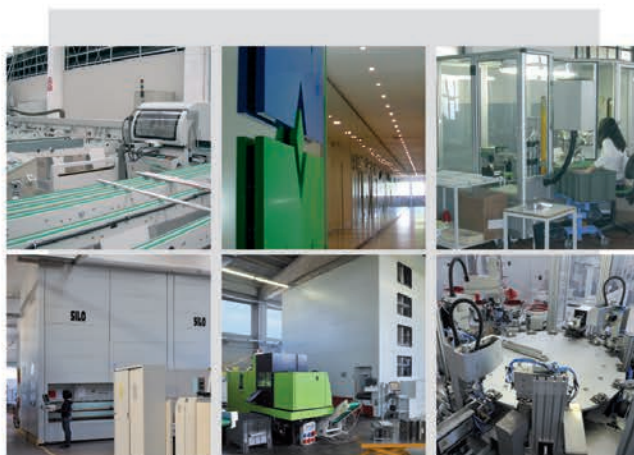

3

MOTTURA NEL MONDO

I sistemi per tende drappeggiate Mottura sono sulle finestre del mondo. Dal 1963 Mottura produce soluzioni ovunque ci sia una finestra; residenze, comunità, grandi progetti e nautica.

MOTTURA IN THE WORLD

The Mottura systems for draped curtains dress the windows of the world. Since 1963 Mottura produces solutions where there is a window; in private residence, in commercial structures and in nautical buildings.

LA SICUREZZA

La sicurezza è una priorità e Mottura richiede che i propri sistemi siano sempre installati correttamente per evitare di fare correre seri rischi ai bambini.

SAFETY

Safety is a major priority and Mottura requires that its systems are always installed correctly to avoid serious risks to children.

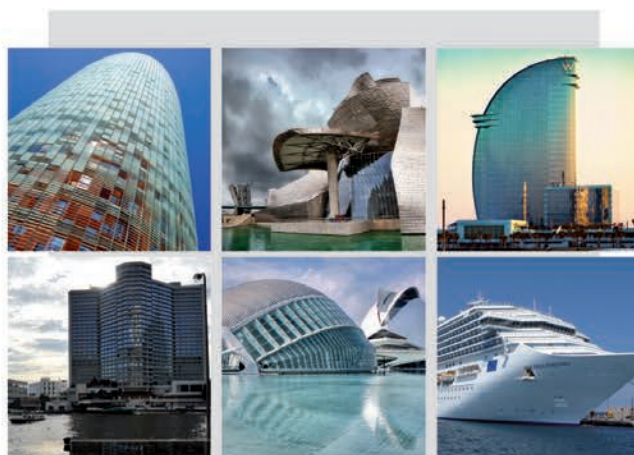

SISTEMI A STRAPPO

HAND-DRAWN SYSTEMS

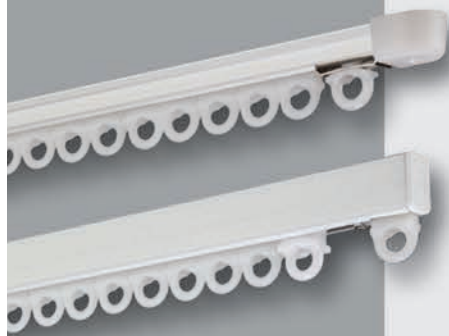

ZENITH 423 - NADIR 426

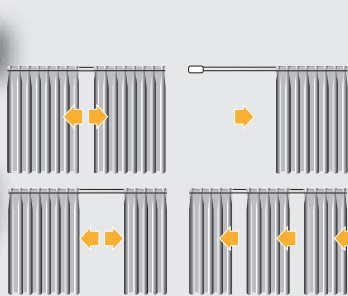

Zenith 423

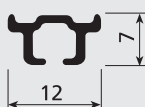

Nadir 426

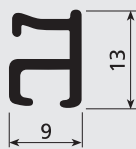

Kg	ref. 4361	2m	4m	6m	8m	Kg	ref. 4361	2m	4m	6m	8m
		3 Kg	5 Kg	2 Kg				1 Kg	2 Kg	1 Kg	
		2 Kg	4 Kg	2 Kg				1 Kg	2 Kg	1 Kg	



Kg	ref. 4361	2m	4m	6m	8m	Kg	ref. 4361	2m	4m	6m	8m
		3 Kg	5 Kg					1 Kg	2 Kg		
		2 Kg	4 Kg					1 Kg	2 Kg		



ORIZZONTE 806 - 466

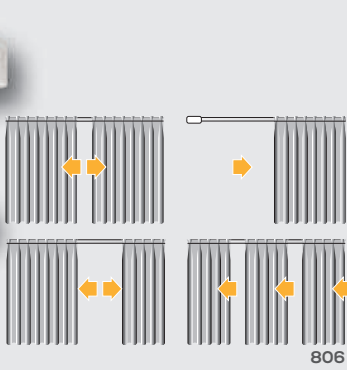

Orizzonte 806

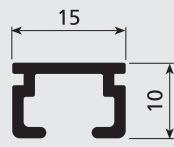

Orizzonte 466

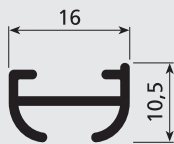

Kg	ref. 4361	2m	4m	6m	8m	Kg	ref. 4361	2m	4m	6m	8m
		8 Kg	6 Kg					3 Kg	3 Kg		
		7 Kg	5 Kg					3 Kg	3 Kg		



ROUND 460

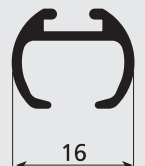
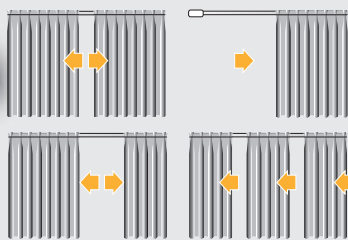

Kg	ref. 4361	2m	4m	6m	8m	Kg	ref. 4361	2m	4m	6m	8m
		6 Kg	8 Kg	5 Kg				3 Kg	3 Kg	2 Kg	
		5 Kg	7 Kg	4 Kg				3 Kg	3 Kg	2 Kg	



ROUND 462

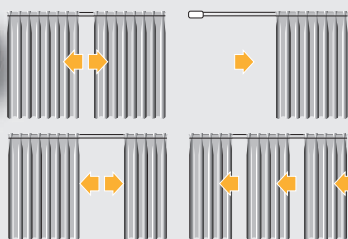

Kg	ref. 4361	2m	4m	6m	8m	Kg	ref. 4361	2m	4m	6m	8m
		8 Kg	10 Kg	7 Kg				3 Kg	4 Kg	3 Kg	
		7 Kg	8 Kg	6 Kg				3 Kg	4 Kg	3 Kg	

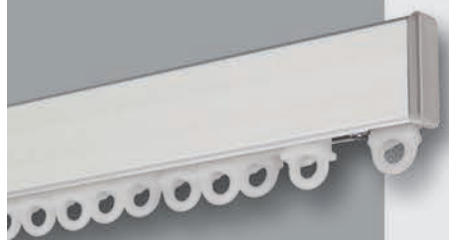

SPIN 417

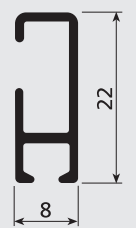
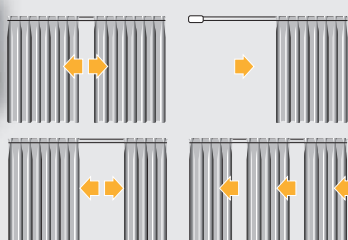

Kg	ref. 4361	2m	4m	6m	8m	Kg	ref. 4361	2m	4m	6m	8m
		8 Kg	10 Kg	7 Kg				3 Kg	4 Kg	3 Kg	
		7 Kg	8 Kg	6 Kg				3 Kg	4 Kg	3 Kg	

SISTEMI A STRAPPO / HAND-DRAWN SYSTEMS

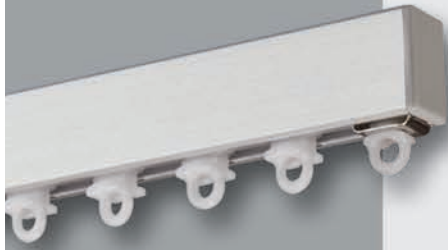

MULTIPLO 412

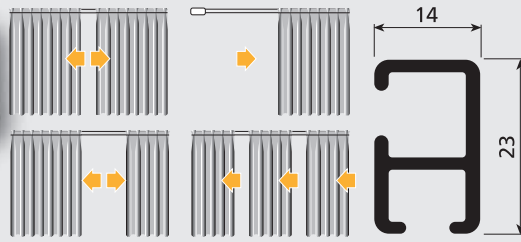

Kg	ref. 4361	2m	4m	6m	8m	Kg	ref. 4361	2m	4m	6m	8m
8	Kg		7			3	Kg		3		
7	Kg		6			3	Kg		3		



ARCO 489

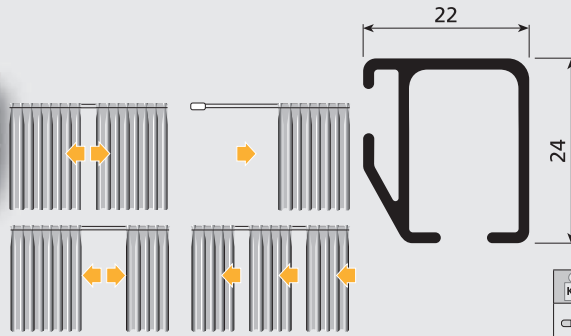

Kg	ref. 4361	2m	4m	6m	8m	Kg	ref. 4361	2m	4m	6m	8m
14	Kg		20		18	6	Kg		8		8
12	Kg		17		15	6	Kg		8		8



SEPARÈ 458

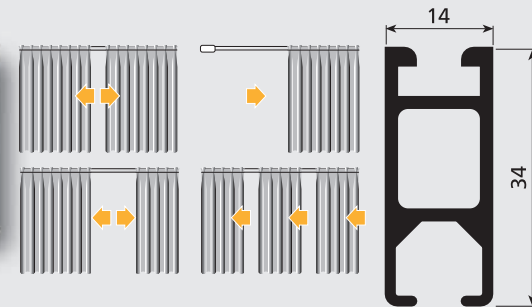

Kg	ref. 4361	2m	4m	6m	8m	Kg	ref. 4361	2m	4m	6m	8m
7	Kg		11		8	3	Kg		5		3
6	Kg		9		7	3	Kg		5		3



LIME 677

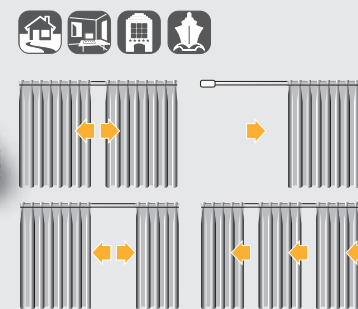

Kg	ref. 4621	2m	4m	6m	8m						
6	Kg		9		6						

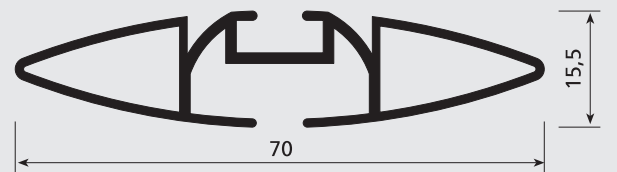

LUNA 577

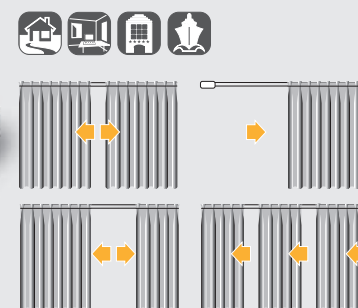

Kg	ref. 4361	2m	4m	6m	8m						
6	Kg		9		6						

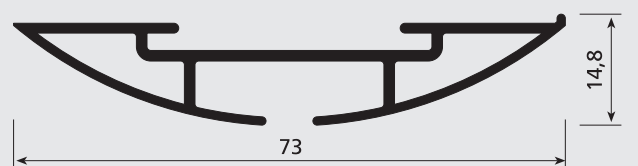

SISTEMI A CORDA

CORD-DRAWN SYSTEMS



SLALOM 430

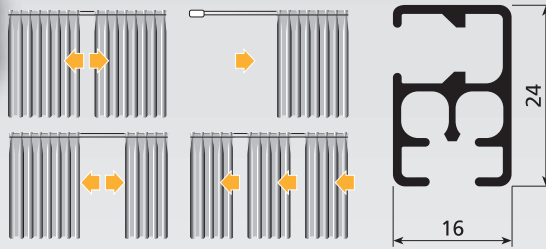

Kg	ref. 4361	2m	4m	6m	8m	Kg	ref. 4361	2m	4m	6m	8m
		7,5 Kg	9 Kg	5 Kg				3 Kg	4 Kg	2 Kg	
		6 Kg	7 Kg	4 Kg				3 Kg	4 Kg	2 Kg	



ARCO 470

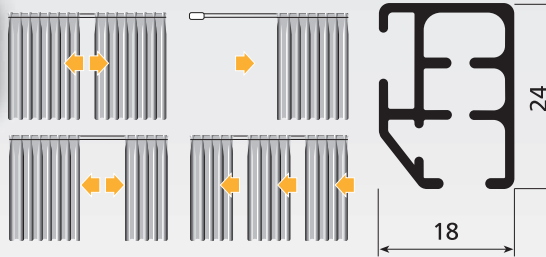

Kg	ref. 4361	2m	4m	6m	8m	Kg	ref. 4361	2m	4m	6m	8m
		10 Kg	12 Kg	8 Kg				4 Kg	5 Kg	3 Kg	
		8 Kg	10 Kg	7 Kg				4 Kg	5 Kg	3 Kg	



ARCO 490

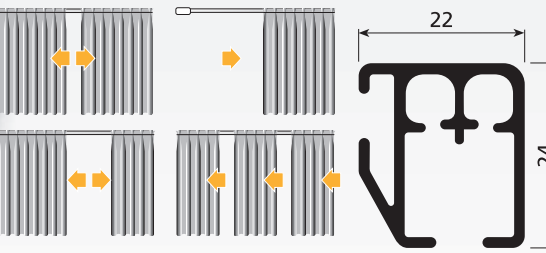

Kg	Arco 490/1 ref. 4361	2m	4m	6m	8m	Kg	Arco 490/1 ref. 4361	2m	4m	6m	8m
		7 Kg	10 Kg	8 Kg				3 Kg	4 Kg	3 Kg	
		6 Kg	8 Kg	7 Kg				3 Kg	4 Kg	3 Kg	



Kg	Arco 490/2 ref. 4361	2m	4m	6m	8m	Kg	Arco 490/2 ref. 4361	2m	4m	6m	8m
		14 Kg	20 Kg	18 Kg				6 Kg	8 Kg	8 Kg	
		12 Kg	17 Kg	15 Kg				6 Kg	8 Kg	8 Kg	



ESSE 433

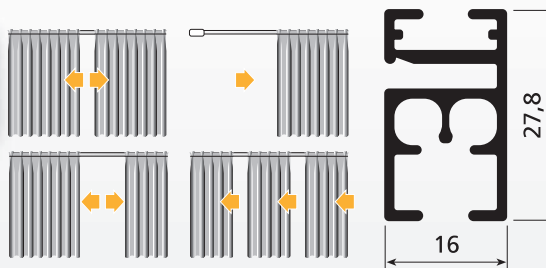

Kg	ref. 4361	2m	4m	6m	8m	Kg	ref. 4361	2m	4m	6m	8m
		7 Kg	10 Kg	6 Kg				3 Kg	4 Kg	3 Kg	
		6 Kg	8 Kg	5 Kg				3 Kg	4 Kg	3 Kg	



KUADRO 482

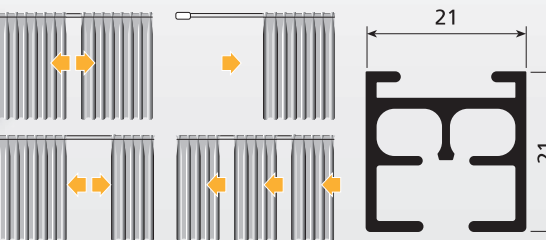

Kg	ref. 4361	2m	4m	6m	8m	Kg	ref. 4361	2m	4m	6m	8m
		7 Kg	10 Kg	6 Kg				3 Kg	4 Kg	3 Kg	
		6 Kg	8 Kg	5 Kg				3 Kg	4 Kg	3 Kg	



EGO 480

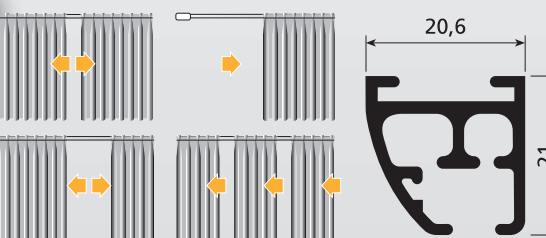

Kg	ref. 4361	2m	4m	6m	8m	Kg	ref. 4361	2m	4m	6m	8m
		7 Kg	10 Kg	6 Kg				3 Kg	4 Kg	3 Kg	
		6 Kg	8 Kg	5 Kg				3 Kg	4 Kg	3 Kg	

SISTEMI A CORDA / CORD-DRAWN SYSTEMS



PROGETTO 420

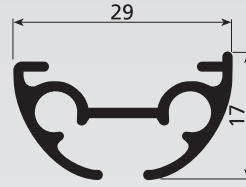
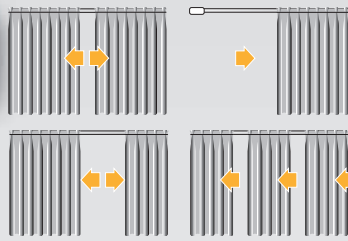

Kg	ref. 4361	2m	4m	6m	Kg	ref. 4361	2m	4m	6m
		6 Kg	8 Kg	5 Kg					
							3 Kg	3 Kg	2 Kg



BEST 421

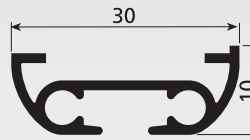
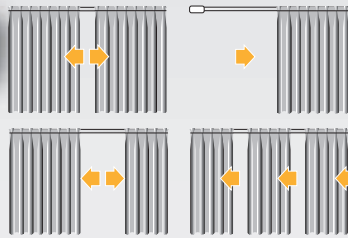

Kg	ref. 4361	2m	4m	6m					
		5 Kg	7 Kg	4 Kg					

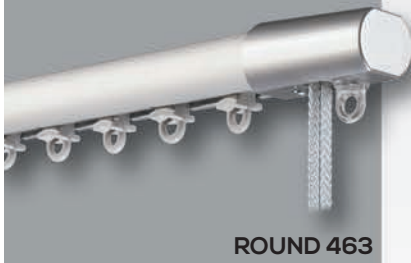

ROUND 463

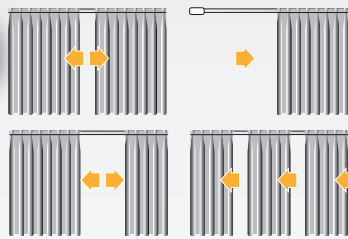

Kg	ref. 4361	2m	4m	6m	8m				
		4 Kg	6 Kg	4 Kg					

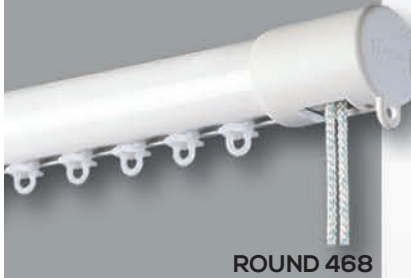

ROUND 468

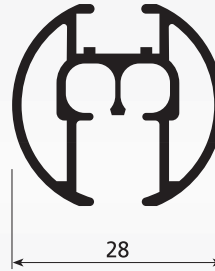
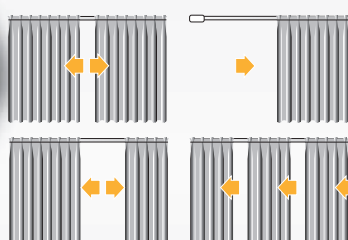

Kg	ref. 4361	2m	4m	6m	8m	Kg	ref. 4361	2m	4m	6m	8m
		6 Kg	8 Kg	4 Kg				3 Kg	3 Kg	2 Kg	
		5 Kg	7 Kg	3 Kg				3 Kg	3 Kg	2 Kg	

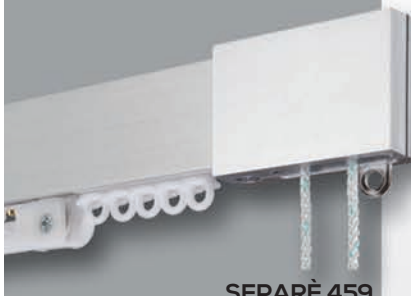

SEPARÈ 459

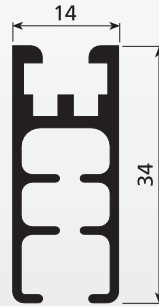
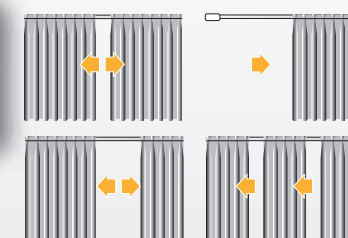

Kg	ref. 4361	2m	4m	6m	8m	Kg	ref. 4361	2m	4m	6m	8m
		8 Kg	11 Kg	10 Kg	6 Kg			3 Kg	5 Kg	4 Kg	3 Kg
		7 Kg	9 Kg	8 Kg	5 Kg			3 Kg	5 Kg	4 Kg	3 Kg



SIPARIO 202

Kg	ref. 5018	2m	4m	6m	8m	10m	12m	14m	16m	Kg	ref. 5018	2m	4m	6m	8m	10m	12m	14m	16m	
		13 Kg	38 Kg	50 Kg	50 Kg	43 Kg	33 Kg	23 Kg				4 Kg	15 Kg	18 Kg	18 Kg	18 Kg	33 Kg	25 Kg	17 Kg	
		10 Kg	31 Kg	41 Kg	41 Kg	35 Kg	27 Kg	19 Kg				4 Kg	15 Kg	18 Kg	18 Kg	18 Kg	33 Kg	25 Kg	17 Kg	

Kg	ref. 5028	2m	4m	6m	8m	10m	12m	14m	16m	Kg	ref. 5028	2m	4m	6m	8m	10m	12m	14m	16m	
		15 Kg	40 Kg	55 Kg	55 Kg	45 Kg	35 Kg	25 Kg				6 Kg	17 Kg	23 Kg	23 Kg	23 Kg	19 Kg	15 Kg	11 Kg	
		12 Kg	33 Kg	46 Kg	46 Kg	37 Kg	29 Kg	21 Kg				6 Kg	17 Kg	23 Kg	23 Kg	23 Kg	19 Kg	15 Kg	11 Kg	

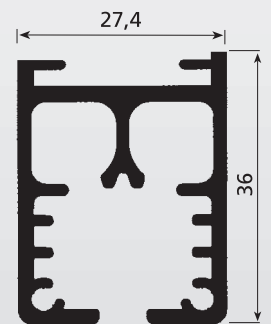
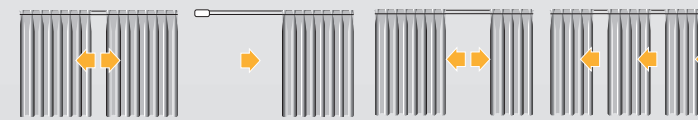

- Domestic**
Domestic
- Separazione ambienti**
Partitioning
- Grandi ambienti**
Meeting rooms
- Nautica**
Boats
- Docce**
Bathrooms
- Curva a 90°**
90° curve
- Uffici**
Offices
- Hotel**
Hotels
- Autobus, Caravan**
Autobus, Caravan
- Sospensione quadri**
Pictures hanging
- Arco**
Arch
- Curva ad ampio raggio**
Large radius curve

SISTEMI A CORDA / CORD-DRAWN SYSTEMS



TEATRO 404

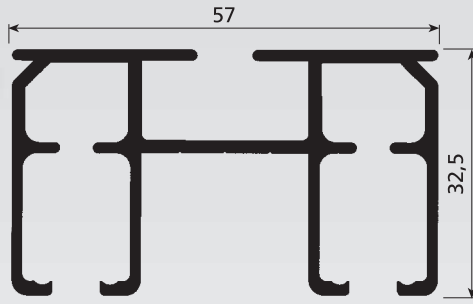

Kg	ref. 5018	2m	4m	6m	8m	10m	12m	14m	16m	18m	20m
—	—	8 Kg	18 Kg	25 Kg	35 Kg	40 Kg	50 Kg	50 Kg	43 Kg	32 Kg	18 Kg

Kg	ref. 5028	2m	4m	6m	8m	10m	12m	14m	16m	18m	20m
—	—	10 Kg	20 Kg	30 Kg	40 Kg	45 Kg	55 Kg	55 Kg	45 Kg	35 Kg	20 Kg

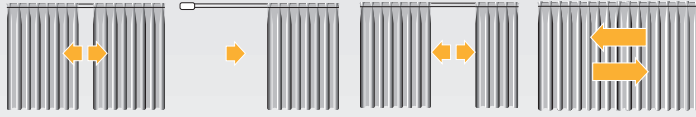

STRALYS 477

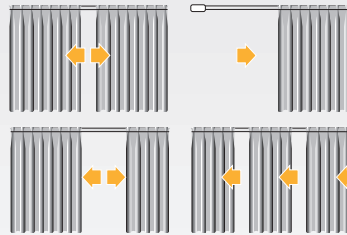

Kg	ref. 4361	2m	4m	6m	8m						
—	—	6 Kg	9 Kg	6 Kg							

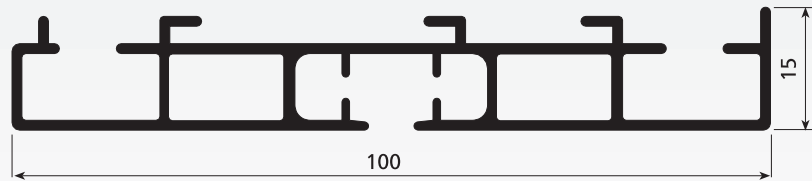

SISTEMI PER TENDE MULTIPLE MULTIPLE CURTAINS SYSTEMS



SURF 311

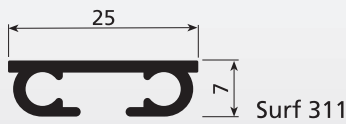
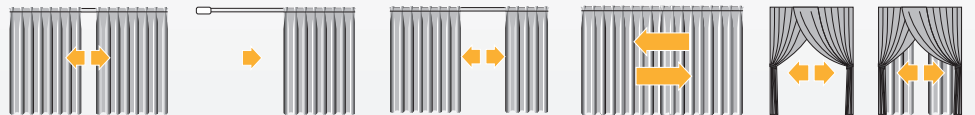

Kg	ref. 4361	2m	4m	6m	8m	Kg	ref. 4361	2m	4m	6m	8m
—	—	6 Kg	9 Kg	6 Kg		—	—				
—	—					—	—	3 Kg	4 Kg	3 Kg	

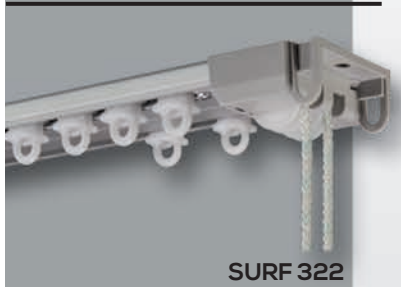

SURF 322



SURF 324

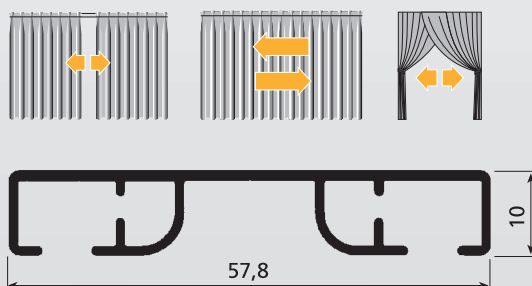

Kg	ref. 4361	2m	4m	6m	8m	10m	12m	14m	16m
—	—	6 Kg	10 Kg	6 Kg					

SISTEMI PER TENDE MULTIPLE MULTIPLE CURTAINS SYSTEMS

MODULO 105

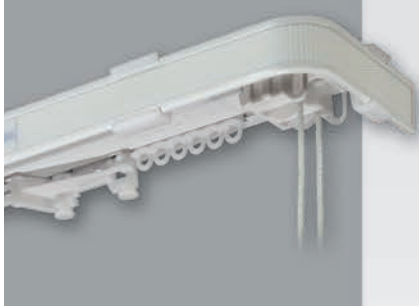

max 6Kg
L/W
600 cm
max

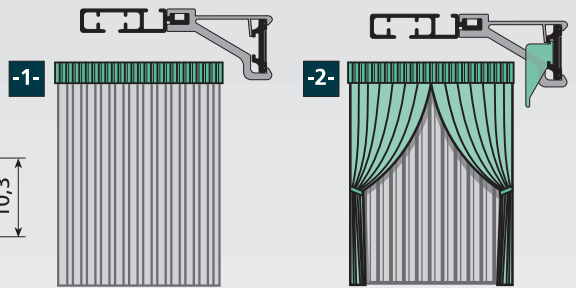

MODULO 205

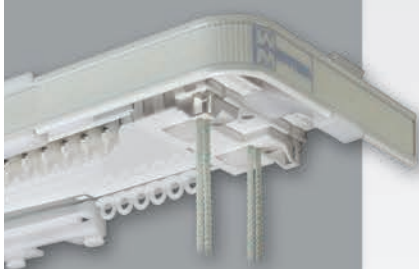

max 6Kg
L/W
600 cm
max

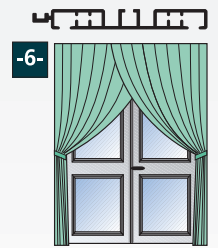
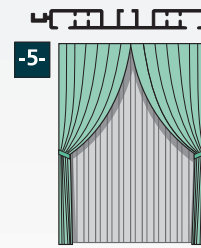
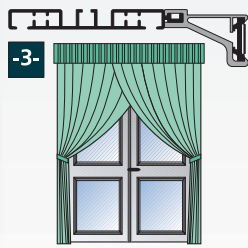
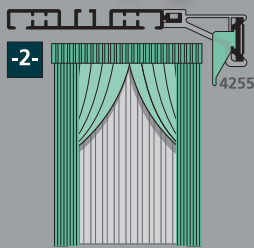
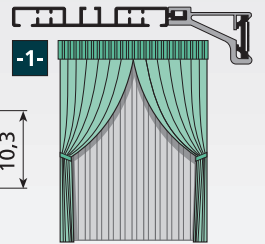
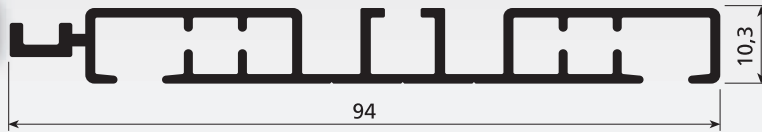

MODULO 305-306



max 6Kg
L/W
600 cm
max

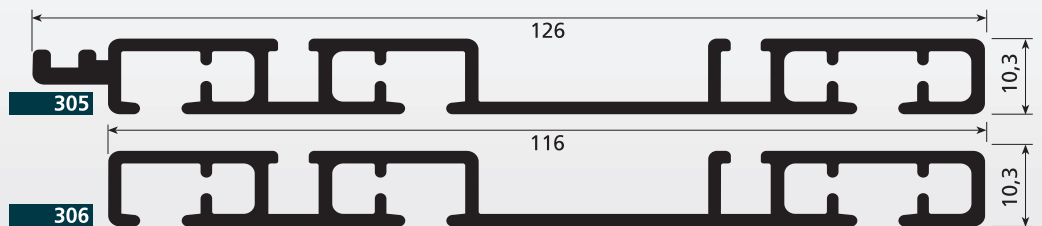
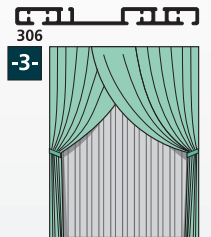
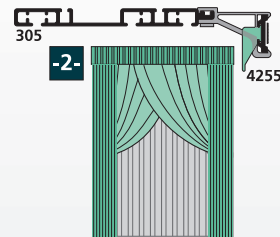
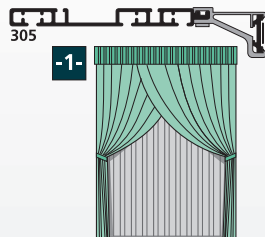

MODULO 405-406



max 6Kg
L/W
700 cm
max

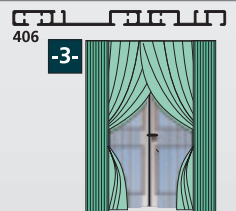
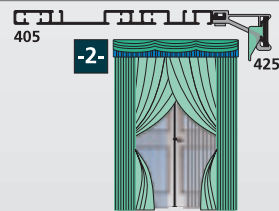
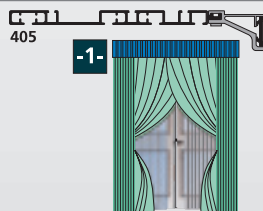

SISTEMI PER DRAPPEGGI AD ONDA

WAVE CURTAINS SYSTEMS

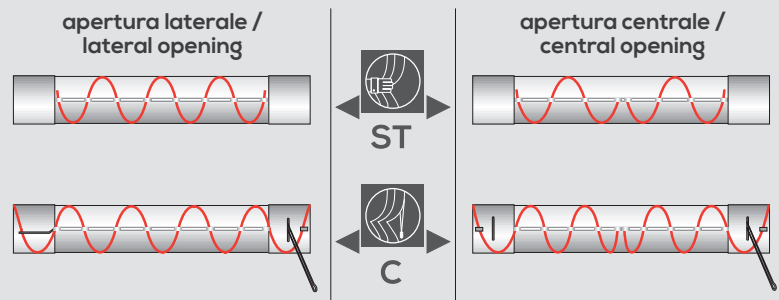

- I sistemi per tende Mottura, sia con azionamento a corde che a strappo, sono adatti per tende ad arriacciatura continua ad onda. L'arriacciatura continua della tenda è realizzata per mezzo di una corda distanziatrice all'interno del canale di scorrimento degli scivoli.
- Mottura systems, either cord drawn and hand drawn are suitable for continuous wave draping. Continuous curtain draping is achieved by means of a spacer cord inside the channel along which the sliders run.

Sistema / System		
STRALYS 477	•	•
LUNA 577	•	
LIME 677	•	
ESSE 433	•	•
KUADRO 482	•	•
EGO 480	•	

Sistema / System		
PROGETTO 420	•	•
SEPARÈ 459	•	•
SEPARÈ 458	•	
ROUND 468		•
ROUND 464	•	
ARCO 489	•	

SISTEMI AD INCASSO

CONCEALED CURTAINS SYSTEMS



CASPER 101 e 201

Sistema ad incasso per tende arriciate indicato per uso domestico ed alberghiero, destinato ad applicazioni in controsoffitti in cartongesso per la sospensione di sottotende (Casper 101) o per la sospensione di tende o sovratende che necessitano di un ampio sormonto (Casper 201).

Concealed system for draperies for domestic and hotels
System designed for applications in plasterboard false ceilings for single curtains (Casper 101) or or curtains/overcurtains that require a large overlap (Casper 201).

Kg	Casper 101 ref. 4263	2m	4m	6m	8m	Kg	Casper 201 ref. 4263	2m	4m	6m	8m
		4 Kg	5 Kg					4 Kg	6 Kg		
		3 Kg	4 Kg								
		3 Kg	4 Kg								



CASPER 101

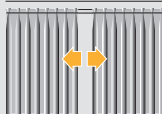

CASPER 201

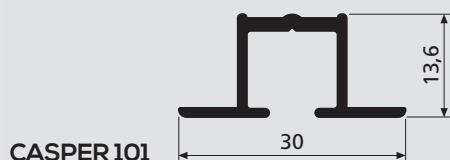
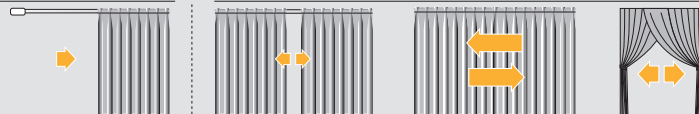

CASPER 101

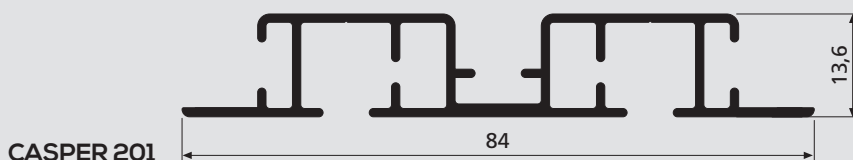

CASPER 201

FEATURES

SISTEMA SYSTEM			R. min.	R. min.	R. min.	Artt./Ref. 4552/1 4552/2	Artt./Ref. 4263-4064 4361	Artt./Ref. 4144-4330 4167-4061	Artt./Ref. 5017-5018	Artt./Ref. 4185-4585	Artt./Ref. 4087 4182+4184 4181+4184	Artt./Ref. 4555	Artt./Ref. 4604 4605
SLALOM 430 	•	•	12 cm	50 cm			4263 4064			•	•		
ARCO 470 	•	•	12 cm	50 cm			4263 4064	•		•	•		
ARCO 490 	•	•	12 cm	50 cm			4263 4064	•	•	•	• (+5237)		
ESSE 433 	•	•	12 cm	50 cm		•	4263	•		•	•	•	•
KUADRO 482 	•	•	12 cm	50 cm		•	4263	•		•	•	•	•
EGO 480 	•	•	12 cm	50 cm		•	4263 4064	•		•	•	•	•
PROGETTO 420 	•			150 cm			4263 4064	•		•	•	•	•
BEST 421 	•						4263 4064	•		•	•		
ROUND 468 	•	•	30 cm	50 cm		•	4263 4064	•		•	•	•	•
ROUND 463 	•	•	30 cm	50 cm			4263			•			
ROUND 460 - 462 	•	•	12/30 cm	50 cm		•	4263				•		
SEPARÉ 458* - 459 	•	•	12 cm	50 cm		•	4263 4064	•		•	•	•	•
SIPARIO 202 	•	•	30 cm	50 cm			4263 4064	•	•				
TEATRO 404 	•	•					4263 4064	•	•				
LUNA 577 	•					•	4263	•					•
STRALYS 477 - LIME 677 	•	•				•	4263	•					•
ZENITH 423 	•		6/12 cm	50 cm			4361						
NADIR 426 	•	•	10 cm	50 cm			4361	•					
ORIZZONTE 466 - 806 	•	•	12 cm	50 cm			4263 4064	•					
SPIN 417 	•	•	10 cm	50 cm	50 cm		4361						
MULTIPLO 412 	•	•	12 cm	50 cm		•	4263 4064	•					
ARCO 489 	•	•	12 cm	50 cm		•	4263 4064	•	• (+5027/28)	•	• (+5237)		•
SURF 311 - 322* 	•				100 cm		4263 4064			•	•		
SURF 324 	•						4263 4064			•	•		
MODULO 	•	•					4263 4064	•		•	•		
CASPER 101 (A.INCASSO/RECESSED) 			30 cm	100 cm		•	4263	•			•		•
CASPER 201 (A.INCASSO/RECESSED) 						•	4263	•			•		•